

REV.	Description	Date
1	dimensions revised	2020/2/5

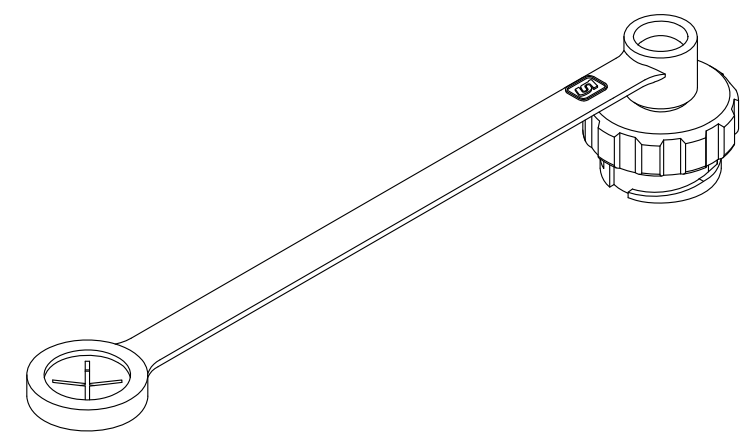

RoHS
TOLERANCE ±0.5

2	Cable tie	PVC	
1	Cap	PA	
Item	Description	Material	Treat & Remark
	DATE	2020/2/5	PART NO. UT-210C-6E
	DWN	GINA	REV. 1
	CHK		
ITEM	Waterproof Cap	UNIT	MM

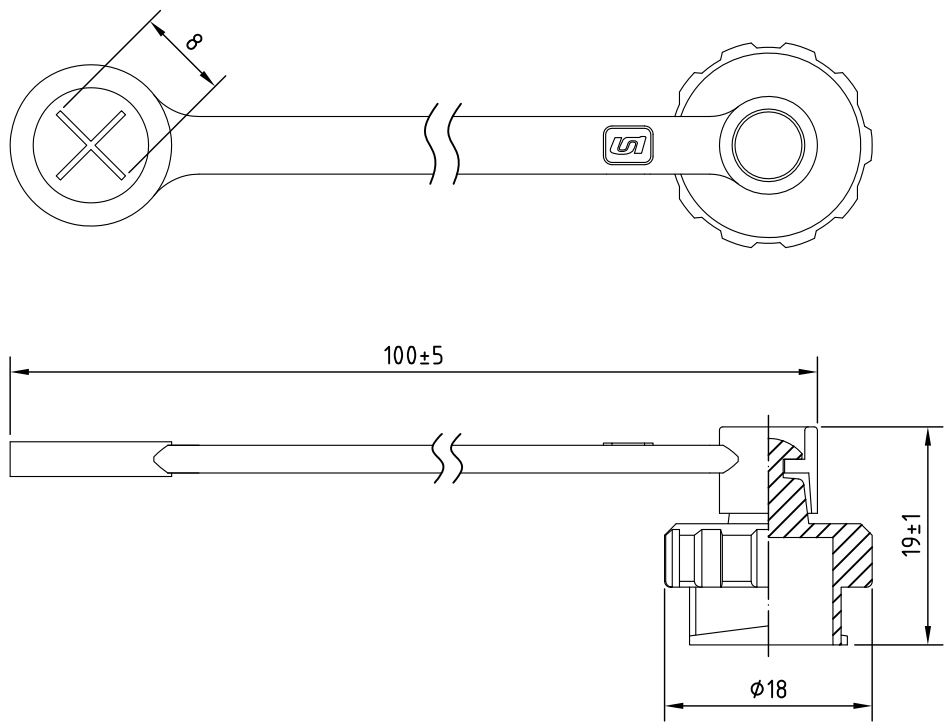

Unicable Co., Ltd. 國陽電業有限公司
5F., No. 111-33, Sec. 4, San Ho Road, San Chung City, Taiwan, R.O.C.
<http://www.unicable.com.tw> TEL:+886-2-2286-2122 FAX:+886-2-2286-1010

DATE
DWN
CHK
UNIT